

MINIMA SLIMLINE

astro

FIRE-RATED

GB

PLEASE READ THE INSTRUCTIONS CAREFULLY BEFORE COMMENCING ASSEMBLY

Live: Normally Brown / Red
Neutral: Normally Blue / Black

FR

LIRE ATTENTIVEMENT LES INSTRUCTIONS AVANT DE COMMENCER LE MONTAGE

Phase: Normalement Brun / Rouge
Neutre: Normalement Bleu / Noir

IT

LEGGERE ATTENTAMENTE LE ISTRUZIONI PRIMA DI COMINCIARE L'ASSEMBLAGGIO

Cavo positivo: normalmente marrone o rosso
Cavo neutro: normalmente blu o nero

DE

LESEN SIE BITTE DIE ANWEISUNGEN SORGFÄLTIG DURCH, BEVOR SIE MIT DEM ZUSAMMENBAUEN BEGINNEN

Phase: Normalerweise Braun / Rot
Nulleiter: Normalerweise Blau / Schwarz

GB If the external cord of this luminaire is damaged, it must be replaced by the manufacturer or a qualified person.

FR Si le câble externe est endommagé, il doit être remplacé par le fabricant ou par une personne agréée.

DE Wenn das externe Netzkabel beschädigt ist, muss es durch den Hersteller oder eine ähnlich qualifizierte Person ersetzt werden.

IT Se il cavo esterno è danneggiato, deve essere sostituito dal costruttore o da personale qualificato.

ESP Si el cable exterior está dañado, debe ser sustituido por el fabricante o una persona cualificada.

SWE Om den externa sladden är skadad måste den bytas ut av tillverkaren eller en kvalificerad person.

POL Uszkodzony przewód zewnętrzny musi wymienić producent lub wykwalifikowana osoba.

FIN Jos ulkoinen johto on vaurioitunut, valmistajan tai pätevän henkilön on vaihdettava se.

Y

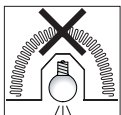

NOT SUITABLE FOR COVERING WITH THERMAL INSULATION.

Ne peut être recouvert de matériaux d'isolation.

Non adatto ad essere coperto da isolanti termici.

Nicht für die Abdeckung mit Wärmedämmung geeignet.



FOR CEILING USE ONLY

Seulement pour montage au plafond

Da utilizzarsi solo al soffitto

Nur für den Deckengebrauch

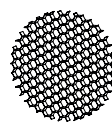
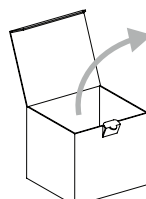
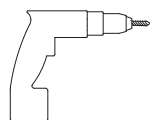
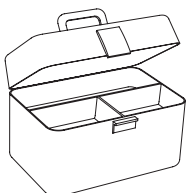

x1

Glare guard

Protection anti-éblouissement

Protezione antiabbagliamento

Antiblendschutz

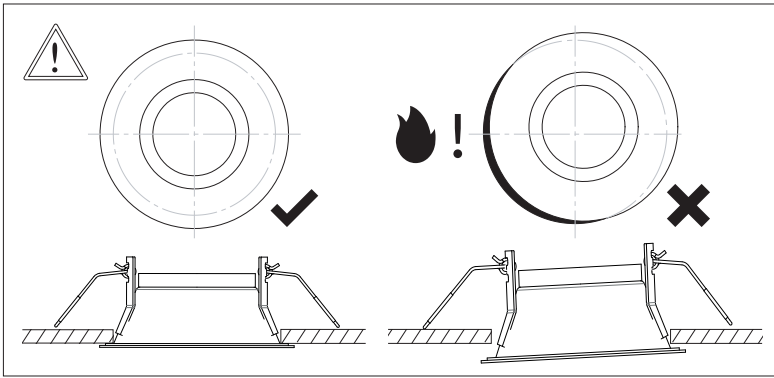

CEILING TYPES / TYPES DE PLAFOND / TIPI DI SOFFITTO / DECKENARTEN:

Ceiling lining secured directly to timber joists / Revêtement de plafond fixé directement aux solives en bois / Rivestimento del soffitto fissato direttamente ai travetti in legno / Deckenverkleidung direkt an hölzernen Deckenbalken befestigt	Fire resistance periods to / Périodes de résistance au feu selon / Periodi di resistenza al fuoco secondo / Feuerwiderstandszeiten nach EN 1365-2: 2014 (mins)
Minimum 1 x 15 mm thick Type A or Type F gypsum wallboard to EN 520 / Panneau mural en gypse de type A ou Type F d'une épaisseur minimum de 1 x 15 mm selon EN 520 / Lastra di gesso di tipo A o Tipo F di spessore minimo 1 x 15 mm secondo EN 520 / Mindestens 1 x 15 mm dicke Gipskartonplatte Typ A oder Typ F nach EN 520	30 minutes / minutes / minuti / minuten
Minimum 2 x 12.5 mm thick Type F gypsum FireLine to EN 520 / Gypse coupe-feu de type F d'une épaisseur minimale de 2 x 12,5 mm selon EN 520 / Lastra di gesso FireLine di tipo F di spessore minimo 2 x 12.5 mm secondo EN 520 / Mindestens 2 x 12,5 mm dicke Gipskartonplatte FireLine Typ F nach EN 520	60 minutes / minutes / minuti / minuten
Minimum 3 x 12.5 mm thick Type F gypsum FireLine to EN 520 / Gypse coupe-feu de type F d'une épaisseur minimale de 3 x 12,5 mm selon EN 520 / Lastra di gesso FireLine di tipo F di spessore minimo 3 x 12.5 mm secondo EN 520 / Mindestens 3 x 12,5 mm dicke Gipskartonplatte FireLine Typ F nach EN 520	90 minutes / minutes / minuti / minuten

EN - These products are suitable to install in fire protected timber floor and ceiling systems which have previously been successfully tested for at least 30 minutes, 60 minutes or 90 minutes to EN 1365-2 : 2014 /

FR - Ces produits peuvent être installés dans des systèmes de planchers et de plafonds en bois protection incendie qui ont été testés avec succès pendant au moins 30 minutes, 60 minutes ou 90 minutes selon EN 1365-2 : 2014 /

IT - Questi prodotti possono essere installati in sistemi di pavimento e soffitto in legno antincendio che siano stati testati con successo per almeno 30 minuti, 60 minuti o 90 minuti secondo EN 1365-2: 2014 /

DE - Diese Produkte eignen sich für den Einbau in feuergeschützte Holzboden- und Deckensysteme, die zuvor mindestens 30 Minuten, 60 Minuten oder 90 Minuten erfolgreich nach EN 1365-2: 2014 getestet wurden.

JOIST TYPES / TYPES DE SOLIVES / TIPI DI TRAVETTI / ARTEN DECKENBALKEN

EN - Solid softwood or hard wood timber joists manufactured from strength grade C16 or greater, installed at centres not exceeding 600 mm /
FR - Solives en bois tendre massif ou en bois dur fabriquées à partir de la classe de résistance C16 ou plus, installées à des centres ne dépassant pas 600 mm /

IT - Travetti in legno massiccio dolce o legno duro fabbricati con grado di resistenza C16 o superiore, distanza tra i centri non superiore a 600 mm /
DE - Massive Nadelholz- oder Hartholzbalken, hergestellt aus Festigkeitsklasse C16 oder höher, installiert mittig mit einem Abstand von nicht mehr als 600 mm

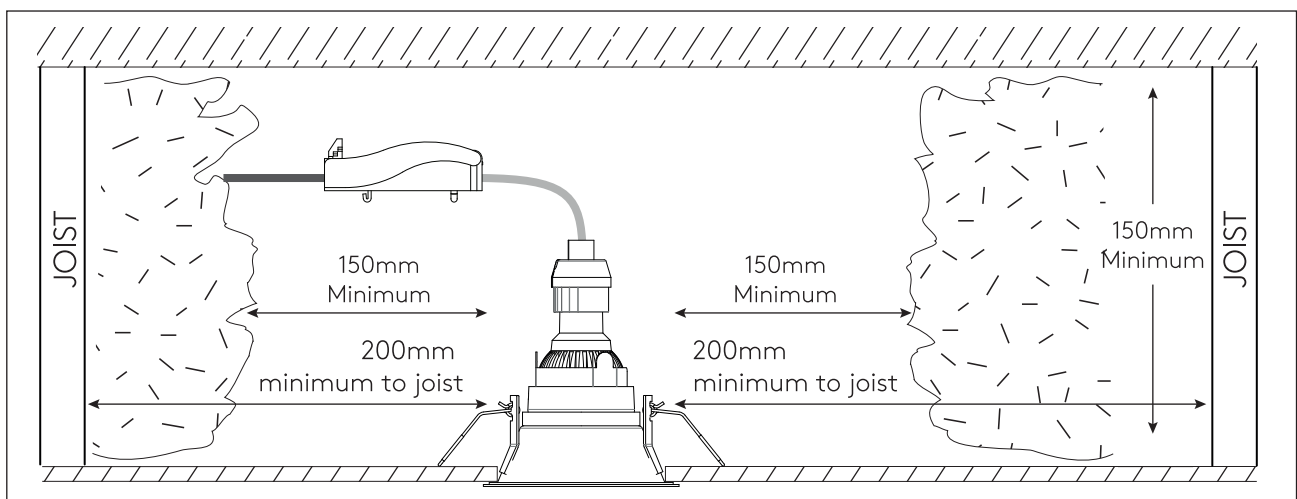

1

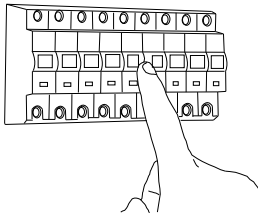

TURN OFF POWER
Couper le courant! /
Spegnere la corrente! /
Strom Abshalten!

2

1 downlight per 0.72m²: 1 metre minimum spacing / Espacement minimum de 1 mètre / Distanza minima di 1 metro / 1 Meter Mindestabstand

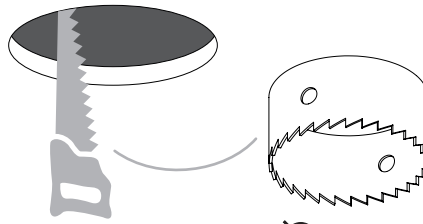

Round Fixed,
Round Adjustable & 25

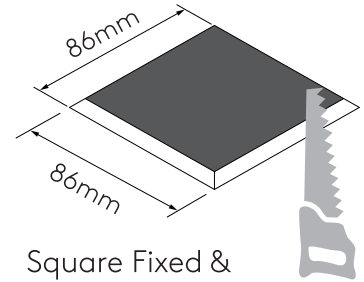

Square Fixed &
Square Adjustable

3

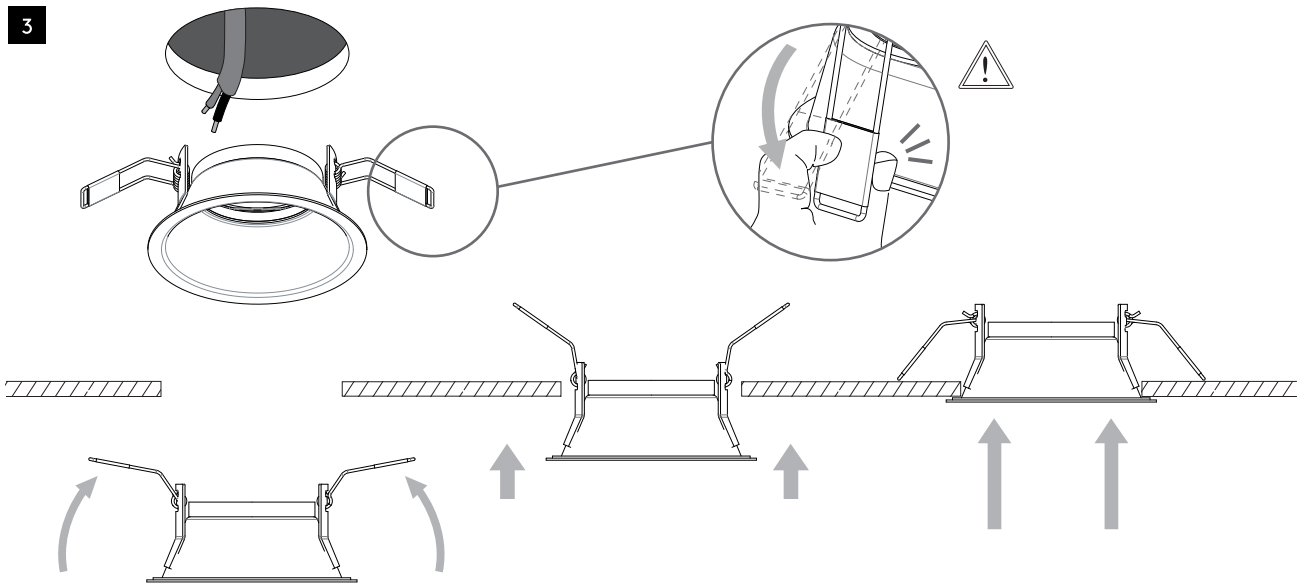

4

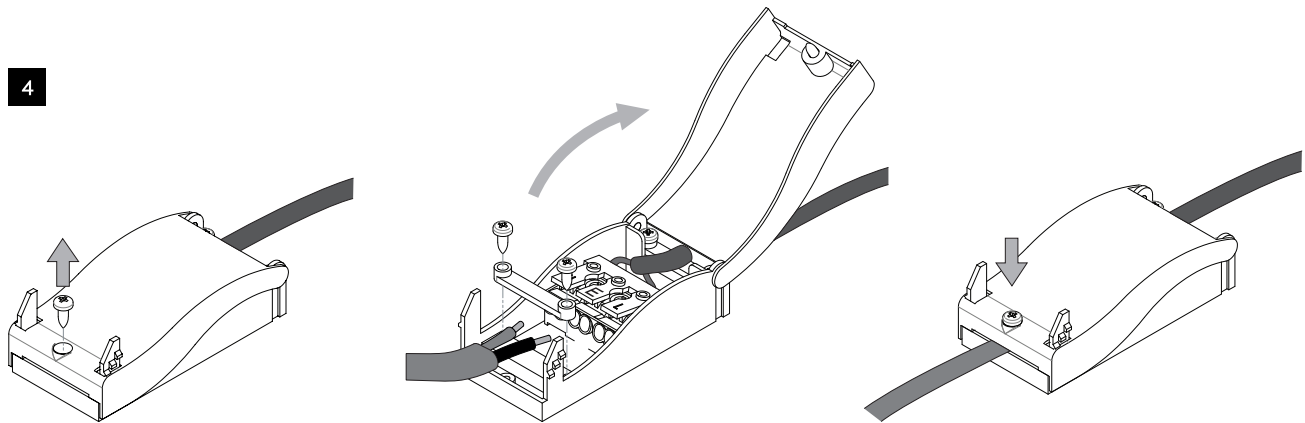

Neutral/Neutre/Neutro/Nulleiter
Blue/Black
Bleu/Noir
Azul/Negro

This terminal is for continuity purposes only/
Ce terminal est uniquement à des fins de continuité/
Questo terminale è solo a scopo di continuità/
Dieses Terminal dient nur zu Durchgangszwecken

Live/Phase/Fase
Brown/Red
Brun/Rouge
Marrón/Rojo
Braun/Rot

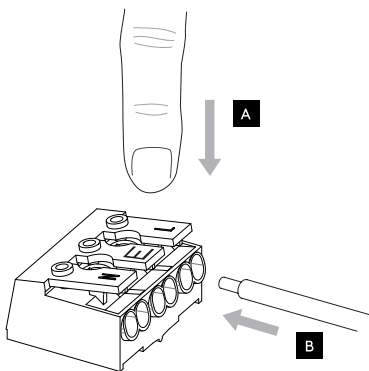

5

C

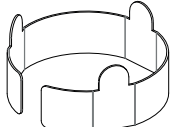

B

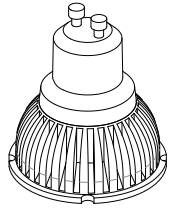

A

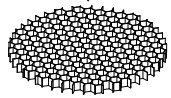

A

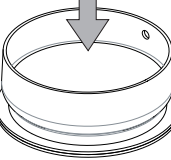

6

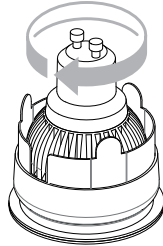
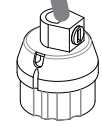

7

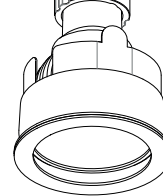
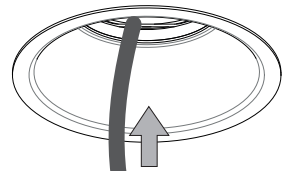

9

