

**GB**

PLEASE READ THE INSTRUCTIONS CAREFULLY BEFORE COMMENCING ASSEMBLY

Live: Normally Brown / Red  
Neutral: Normally Blue / Black

**FR**

LIRE ATTENTIVEMENT LES INSTRUCTIONS AVANT DE COMMENCER LE MONTAGE

Phase: Normalement Brun / Rouge  
Neutre: Normalement Bleu / Noir

**IT**

LEGGERE ATTENTAMENTE LE ISTRUZIONI PRIMA DI COMINCIARE L'ASSEMBLAGGIO

Cavo positivo: normalmente marrone o rosso  
Cavo neutro: normalmente blu o nero

**DE**

LESEN SIE BITTE DIE ANWEISUNGEN SORGFÄLTIG DURCH, BEVOR SIE MIT DEM ZUSAMMENBAUEN BEGINNEN

Phase: Normalerweise Braun / Rot  
Nulleiter: Normalerweise Blau / Schwarz

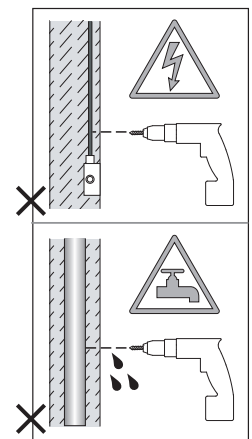

**GB** If the external cord of this luminaire is damaged, it must be replaced by the manufacturer or a qualified person.

**FR** Si le câble externe est endommagé, il doit être remplacé par le fabricant ou par une personne agréée.

**DE** Wenn das externe Netzkabel beschädigt ist, muss es durch den Hersteller oder eine ähnlich qualifizierte Person ersetzt werden.

**IT** Se il cavo esterno è danneggiato, deve essere sostituito dal costruttore o da personale qualificato.

**ESP** Si el cable exterior está dañado, debe ser sustituido por el fabricante o una persona cualificada.

**SWE** Om den externa sladden är skadad måste den bytas ut av tillverkaren eller en kvalificerad person.

**POL** Uszkodzony przewód zewnętrzny musi wymienić producent lub wykwalifikowana osoba.

**FIN** Jos ulkoinen johto on vaurioitunut, valmistajan tai pätevän henkilön on vaihdettava se.

Y

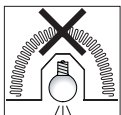

NOT SUITABLE FOR COVERING WITH THERMAL INSULATION.

Ne peut être recouvert de matériaux d'isolation.

Non adatto ad essere coperto da isolanti termici.

Nicht für die Abdeckung mit Wärmedämmung geeignet.



FOR CEILING USE ONLY

Seulement pour montage au plafond

Da utilizzarsi solo al soffitto

Nur für den Deckengebrauch

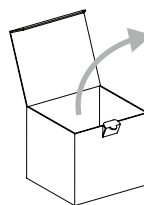
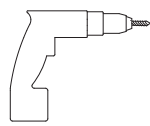
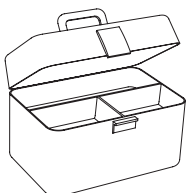

x1

Glare guard

Protection anti-éblouissement

Protezione antiabbagliamento

Antiblendschutz

1

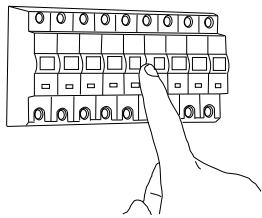

TURN OFF POWER  
Couper le courant! /  
Spegnere la corrente! /  
Strom Abshalten!

2

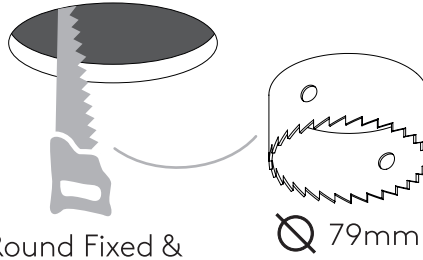

Round Fixed &  
Round Adjustable

Ø 79mm

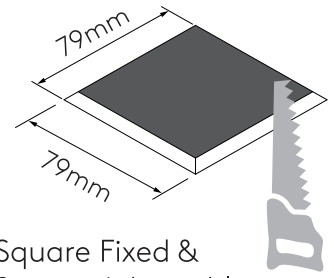

Square Fixed &  
Square Adjustable

3

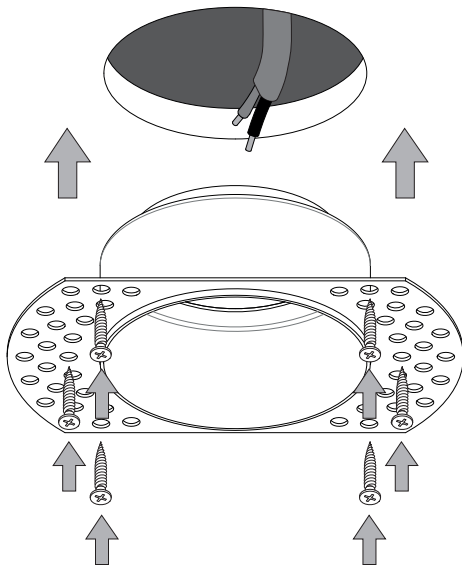

4

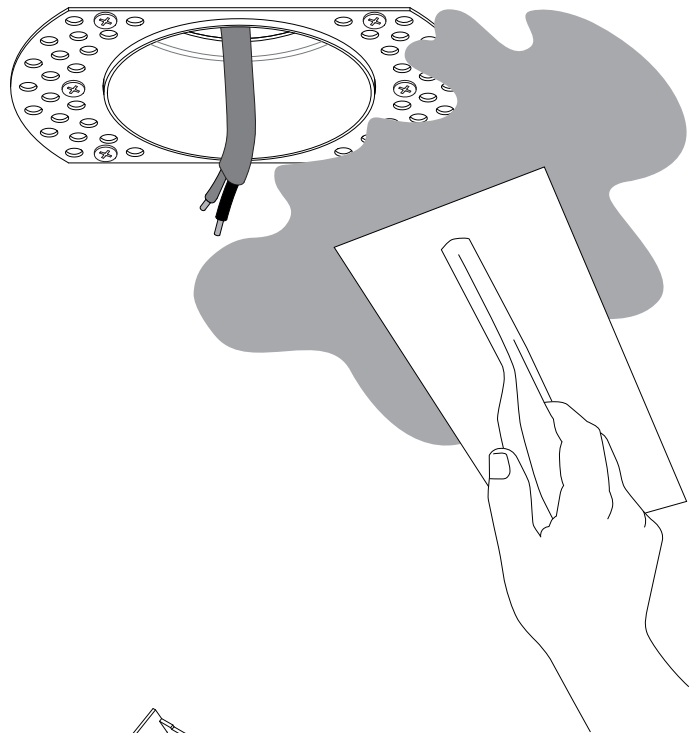

! FIXINGS NOT INCLUDED /  
• Fixations non incluses /  
Elementi di fissaggio  
non inclusi /  
Befestigungen  
nicht eingeschlossen

5

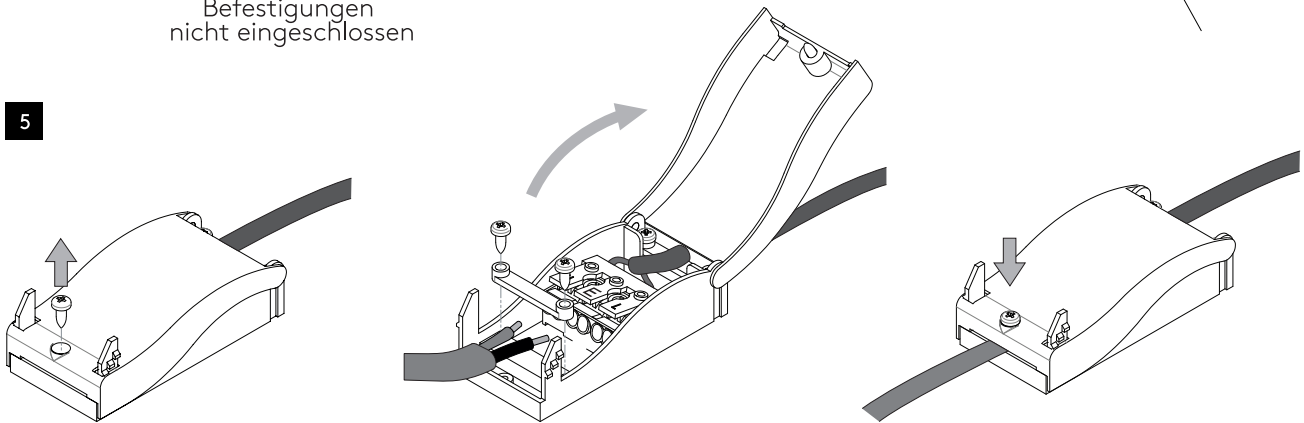

Neutral/Neutre/Neutro/Nulleiter  
Blue/Black  
Bleu/Noir  
Azul/Negro

This terminal is for continuity purposes only/  
Ce terminal est uniquement à des fins de continuité/  
Questo terminale è solo a scopo di continuità/  
Dieses Terminal dient nur zu Durchgangszwecken

Live/Phase/Fase  
Brown/Red  
Brun/Rouge  
Marrón/Rojo  
Braun/Rot

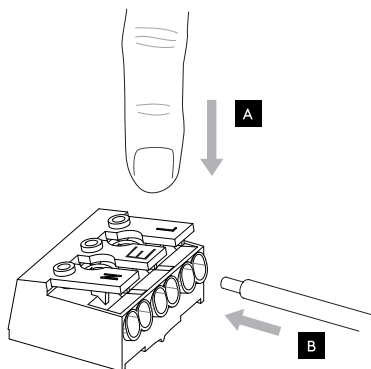

A

B

6

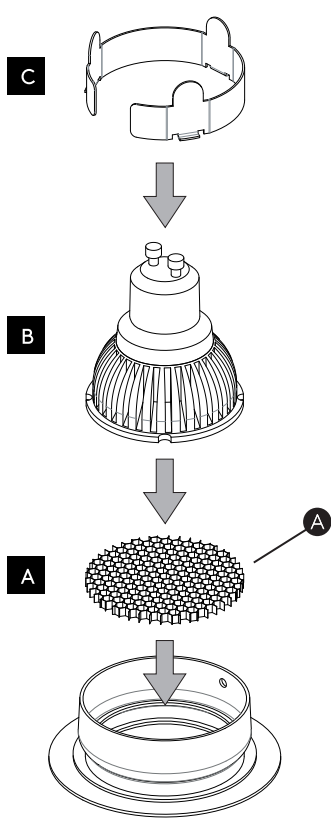

7

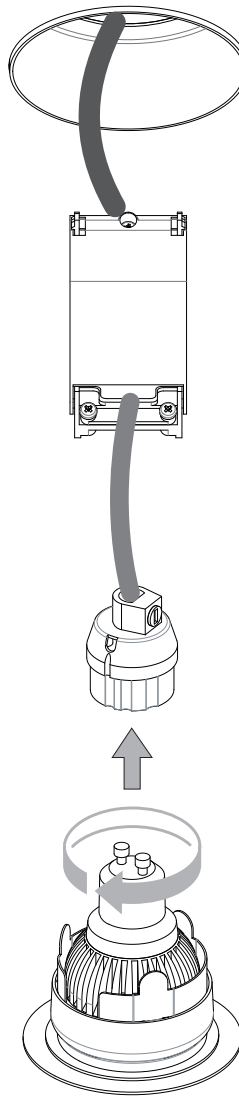

8

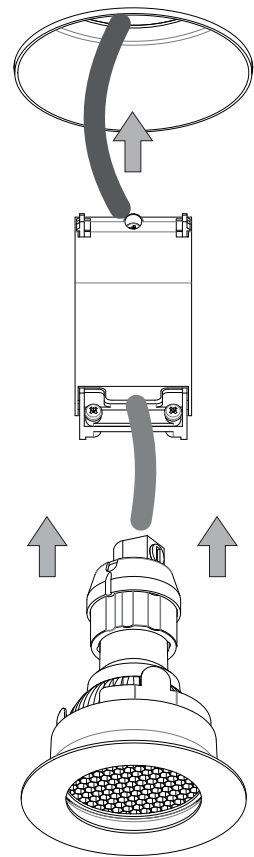

9

