

# PRODUCT DATASHEET

## FL PFM 80 W 3000 K SYM 100 BK

FLOODLIGHT 80 W | Versatile floodlight with up to 10000 lm light output



### Areas of application

- Replacement for floodlights with halogen lamps
- Outdoor use (IP65)
- Industry
- Public areas
- Construction areas
- Building facades

### Product benefits

- Bright, robust and durable
- Safe and very uniform illumination, due to frosted and tempered glass diffuser
- No upper light output ratio (ULOR 0%) when mounted at 0° tilt
- Energy savings of up to 90 % compared to halogen lamp floodlights
- 5 years guarantee

### Product features

- Reflector-based, symmetric light distribution with 100° x 100° beam angle
- Integrated wide voltage driver, suitable for 100 - 277 V AC
- Surge protection: up to 6 kV (L/N-PE), 4 kV (L-N)
- Mounting bracket with 30° angle and wide rotation area
- Breather membrane to optimize air exchange, without compromising IP protection
- Pre-installed, flexible 1 m cable (H05RN-F), wrapped 3 x 1.0 mm<sup>2</sup> single wires



## TECHNICAL DATA

### Electrical data

Nominal wattage	80.00 W
Nominal voltage	100...277 V
Mains frequency	50...60 Hz
Nominal current	430 mA
Inrush current	14.8 A
Inrush current time $T_{h50}$	160 $\mu$ s
Max. no. of lum. on circuit break. B16 A	24
Max. no. of lum. on circuit break. C10 A	17
Max. no. of lum. on circuit break. C16 A	28
Power factor $\lambda$	> 0.90
Total harmonic distortion	< 20 %
Protection class	I
Operating mode	Integrated LED driver

### Photometrical data

Luminous flux	8800 lm
Luminous efficacy	110 lm/W
Color temperature	3000 K
Light color (designation)	Warm White
Color rendering index Ra	$\geq 80$
Standard deviation of color matching	$\leq 5$ sdc <sub>m</sub>
Luminous intensity	-
Flickering metric (Pst LM)	-
Stroboscope effect metric (SVM)	-
Photobiological safety group acc. to EN62778	RG1
Photobiological safety group acc. to EN62471	RG1
Beam angle	100 ° x 100 °

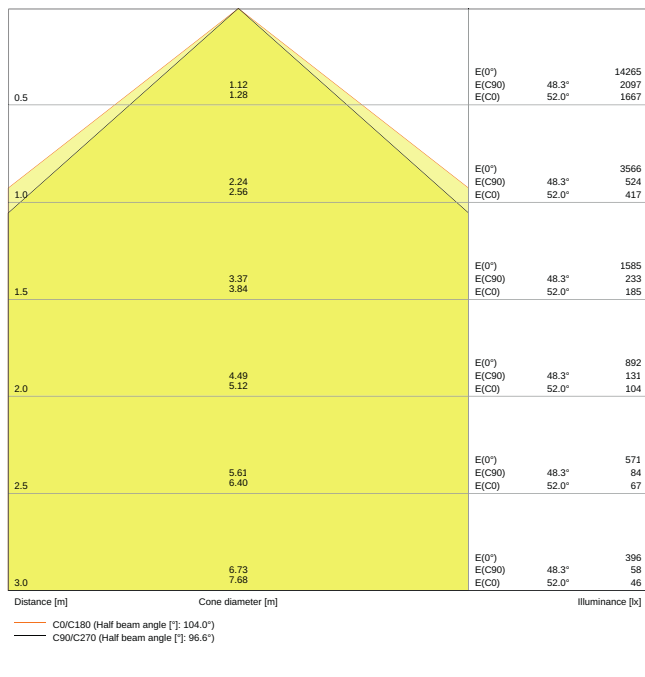

LDC typ cone

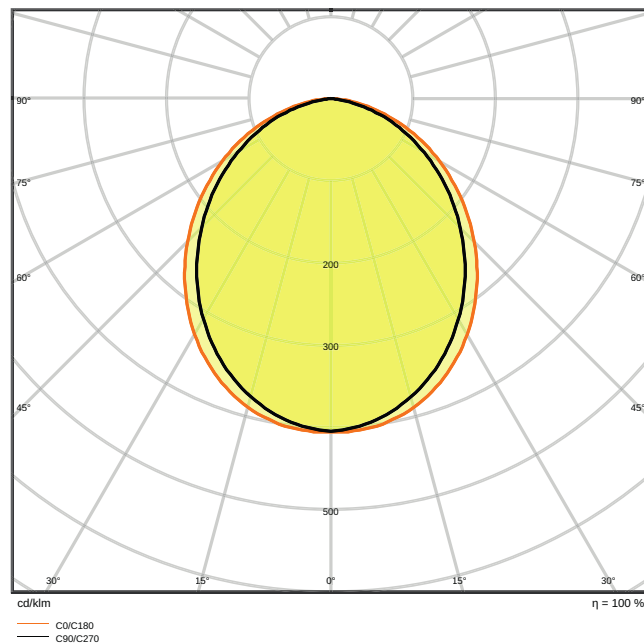

LDC typ polar

## Dimensions & Weight

Length	335.00 mm
Width	250.00 mm
Height	55.00 mm
Product weight	2800.00 g
Cable length	1000 mm

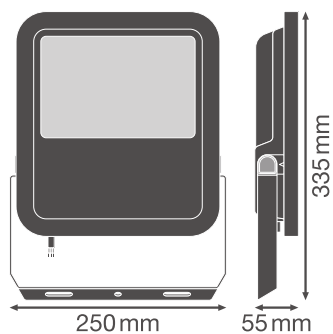

## Materials & Colors

Product color	Black
Housing color	Black
Body material	Aluminum
Light emitting surface material	Glass
Glow Wire Test according to IEC 60695-2-12	650 °C
Mercury content	0.0 mg

## Application & Mounting

Ambient temperature range	-30...+50 °C
Temperature range at storage	-40...+70 °C
Type of connection	Cable, 3-pole
Type of protection	IP65
Protection class IK (shock resistance)	IK08
Dimmable	No
Mounting type	Surface
Mounting location	Wall / Pole / Floor / Ceiling
Adjustable	Yes
LED module replaceable	Not replaceable

## Lifespan

Lifespan L70/B50 at 25 °C	70000 h
Lifespan L80/B10 at 25 °C	55000 h
Lifespan L90/B10 at 25 °C	35000 h
Number of switching cycles	100000

## Control gear

ECG - Output ripple current	< 35 %
-----------------------------	--------









## Certificates & Standards

Standards	CE / CB / ENEC / EAC / RoHS
Luminaire with limited surface temperature, "D sign"	No
Ball shot safe	No

## Safety advice

- Max. wind load surface 0.061 m<sup>2</sup>

DOWNLOAD DATA

DOWNLOAD DATA	
	User instruction FLOODLIGHT 65W - 200W
	Tender documents Tender Text 4058075422506
	Declarations of conformity FLOODLIGHT PFM
	IES file (IES) FL PFM 80W3000K SYM 100 BK
	LDT file (Eulumdat) FL PFM 80W3000K SYM 100 BK
	R3D file (Relux 3D Model) FL PFM 80W
	M4D file (3D Model with rotation axis) FL PFM 80W
	UGR file (UGR table) FL PFM 80W3000K SYM 100 BK
	Packaging insert Legal insert

LOGISTICAL DATA

Product code	Packaging unit (Pieces/Unit)	Dimensions (length x width x height)	Gross weight	Volume
4058075422506	Folding box 1	62 mm x 257 mm x 352 mm	2957.00 g	5.61 dm <sup>3</sup>
4058075422513	Shipping box 2	302 mm x 170 mm x 414 mm	6326.00 g	21.25 dm <sup>3</sup>

The mentioned product code describes the smallest quantity unit which can be ordered. One shipping unit can contain one or more single products. When placing an order, for the quantity please enter single or multiples of a shipping unit.

ADDITIONAL CATALOG INFORMATION

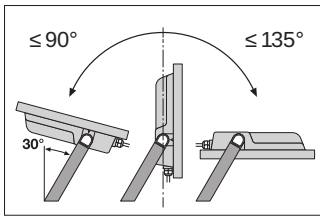

	A	B	C	⚙️	📏
55W	150	108	8,5	2x M8	0,046m <sup>2</sup>
80W	150	108	10,5	2x M10	0,061m <sup>2</sup>
122W	170	118	10,5	2x M10	0,083m <sup>2</sup>
160W	170	118	12,5	2x M12	0,102m <sup>2</sup>
200W	170	118	12,5	2x M12	0,124m <sup>2</sup>

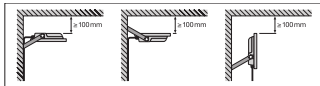
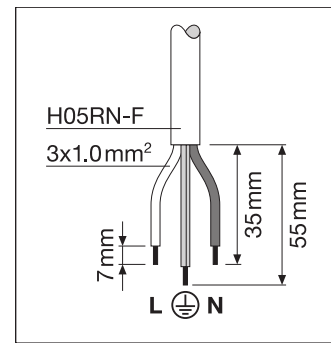

## References / Links

- For Guarantee see [www.ledvance.com/guarantee](http://www.ledvance.com/guarantee)

## DISCLAIMER

Subject to change without notice. Errors and omission excepted. Always make sure to use the most recent release.